

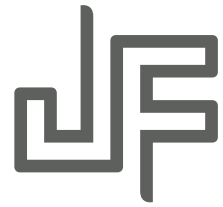

SCAN LOGO WITH JF APP



[jffabrics.com](http://jffabrics.com)

E L E G A N T   **G L I D E**  
D R A P E R Y   H A R D W A R E

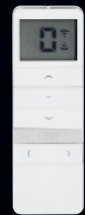

Interactive catalogue

Download the JF app and scan to discover anywhere you see this symbol



TABLE OF CONTENTS

1.375" & 1.5" hand-drawn <b>METAL</b> gallery . . . . .	3 - 13
Glossary of terms . . . . .	14
2" hand-drawn & motorized <b>WOOD</b> gallery . . . . .	15 - 31
Frequently asked questions . . . . .	20
<b>ORDER</b> forms . . . . .	32 - 33
Color sample chips . . . . .	35



1.375" & 1.5" hand-drawn **METAL** gallery

---

6 finishes

---

12 finial styles

---

E L E G A N T **G L I D E**

with **RIPPLEFOLD**® systems – drapery hardware collection

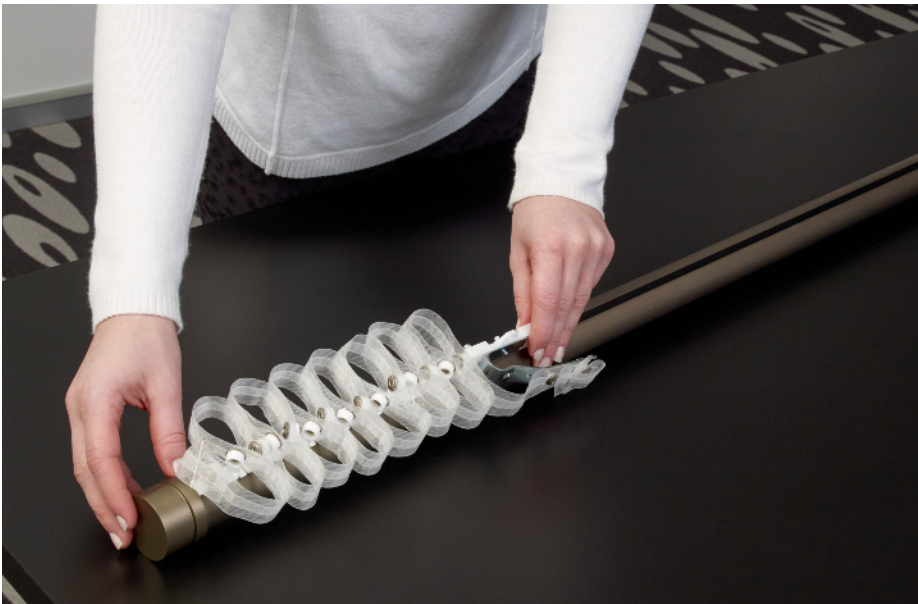

SCAN IMAGE WITH JF APP

**Click and Scan** over the image with our JF app to discover how easy our systems are to use.



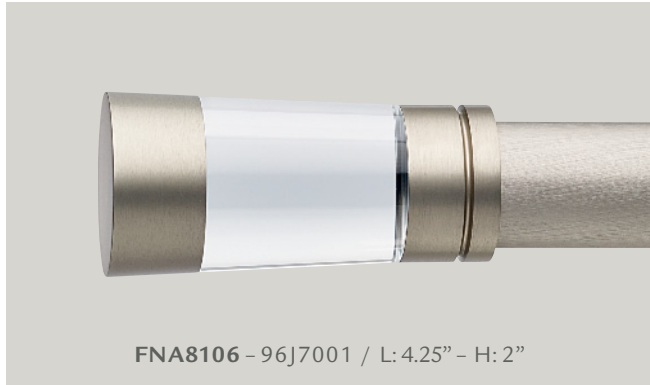

FNA8106 - 96J7001 / L: 4.25" - H: 2"



FNA8100 - 96J7001 / L: 3.75" - H: 3"



FNA8104 - 96J7001 / L: 3.25" - H: 1.75"



FNA8105 - 96J7001 / L: 2.5" - H: 3.25"



FNW8109 - 96J7001 / L: 3.5" - H: 3"



FNW8108 - 96J7001 / L: 3.5" - H: 2.75"



ECM8107 - 96J7001 / L: 1" - H: 1.75"



FNW8101 - 96J7001 / L: 3.5" - H: 3"

TITANIUM - 96J7001

Finials available in 4 finishes, refer to page 9.  
For track options, refer to pages 10 - 13.

72" track

96" track

1.375" diameter metal

METAL GALLERY

1.375"



BRUSHED BRONZE - 97J7001

ELEGANT GLIDE



GRAPHITE - 98J7001

Finials available in 4 finishes, refer to page 9.  
For track options, refer to pages 10 - 13.



72" track

96" track

1.375" diameter metal

METAL GALLERY

1.375"



FNA8100 - 17J7001 / L: 3.75" - H: 3"



FNA8106 - 17J7001 / L: 4.25" - H: 2"



FNA8105 - 17J7001 / L: 2.5" - H: 3.25"



FNA8104 - 17J7001 / L: 3.25" - H: 1.75"

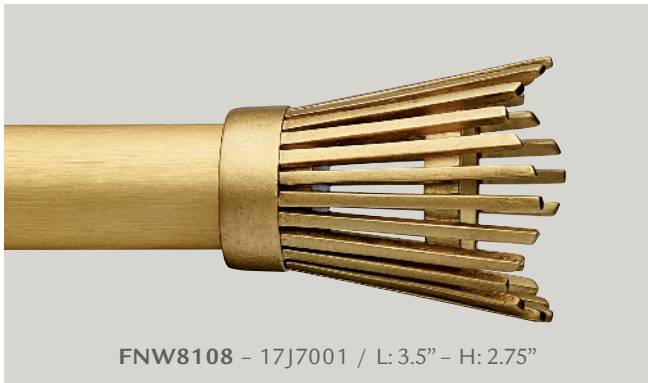

FNW8108 - 17J7001 / L: 3.5" - H: 2.75"



FNW8109 - 17J7001 / L: 3.5" - H: 3"



ECM8107 - 17J7001 / L: 1" - H: 1.75"

BRASS - 17J7001

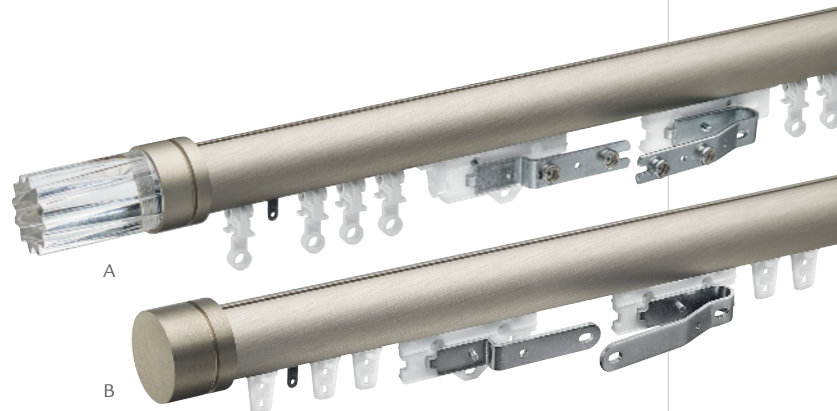

A: Ripplefold® 1.375" track with FNA8104 - 96J7001 finial.  
B: Pleated 1.375" track with ECM8107 - 96J7001 endcap.

E L E G A N T G L I D E

BRUSHED SILVER - 33J7001



FNR13 - 33J7001 / L: 6" - H: 3"

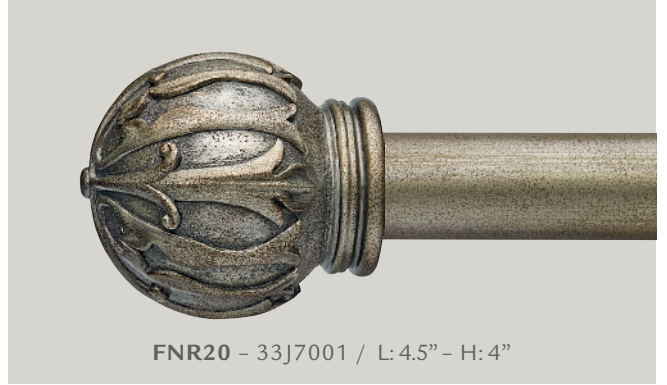

FNR20 - 33J7001 / L: 4.5" - H: 4"



FNR15 - 33J7001 / L: 4.5" - H: 3"



ECR28 - 33J7001 / L: 1" - H: 2.25"

PLATINUM GOLD - 95J7001



FNR13 - 95J7001 / L: 6" - H: 3"

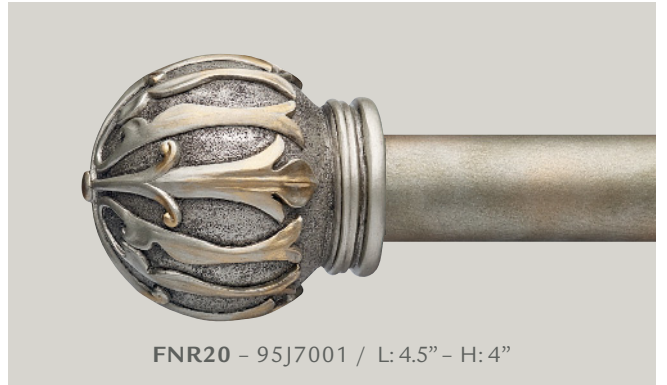

FNR20 - 95J7001 / L: 4.5" - H: 4"



FNR15 - 95J7001 / L: 4.5" - H: 3"



ECR28 - 95J7001 / L: 1" - H: 2.25"

Hand-painted resin finials available in 2 finishes, refer to page 9. For track options, refer to pages 10 - 13.



# metal finishes

sample chips are available on page 35

## Pleated & Ripplefold® 1.375" tracks

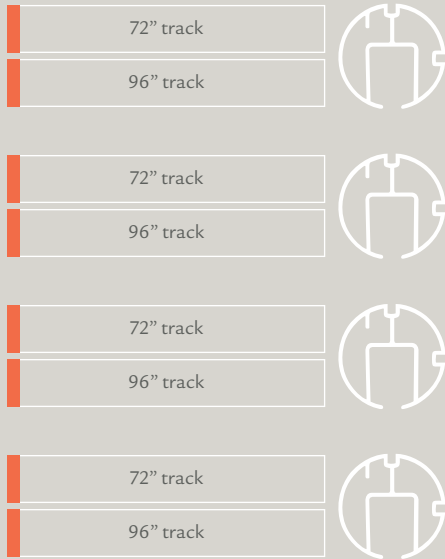

## select finish



17J7001 - Brass



96J7001 - Titanium



97J7001 - Brushed Bronze

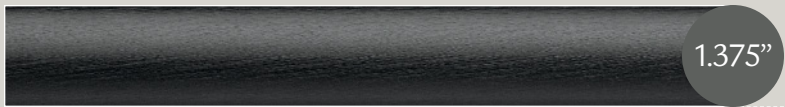

98J7001 - Graphite

finishes for 1.375" tracks

## Pleated & Ripplefold® 1.5" tracks

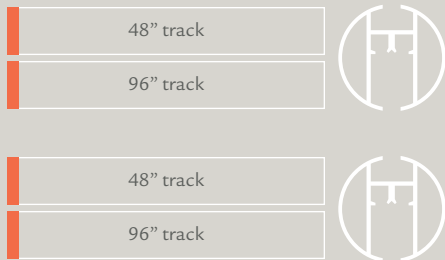

## select finish

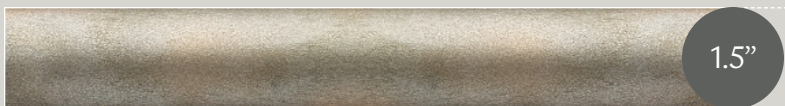

95J7001 - Platinum Gold

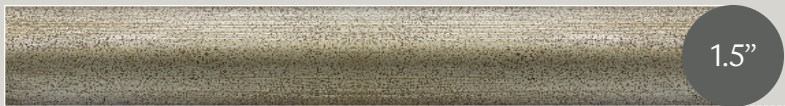

33J7001 - Brushed Silver

finishes for 1.5" tracks



E L E G A N T G L I D E

# how-to-order

1... Select finial/endcap from pages 4-7 (sold separately).

2... Select metal track and finish: available in 4 finishes.

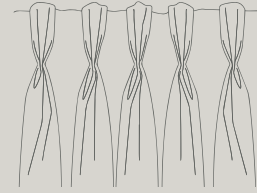

select finish



17J7001  
Brass



96J7001  
Titanium



97J7001  
Brushed Bronze



98J7001  
Graphite

components included with track



track item code	finish code	track length	master carriers	glides	end stops
TRP8111	select finish	72"	one-way / center	24	2
TRP8112	select finish	96"	one-way / center	32	2

3... Select adjustable brackets and finish: available in 4 finishes (sold separately).  
We recommend one bracket for every 3-4 feet.

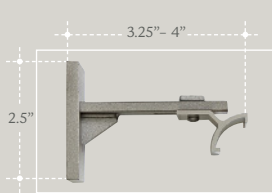

Adjustable single bracket  
TRB8113 - select finish

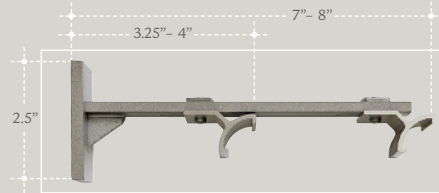

Adjustable double bracket  
TRB8114 - select finish  
**Note:** can also be used as single extension bracket.

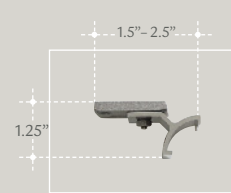

Adjustable ceiling bracket  
TCB8115 - select finish

Additional components (sold separately).



Glide  
TGL8119 - 90J7001



End stop  
TES8120 - 10J7001



Splice  
TSP8116 - 10J7001  
**Note:** one bracket required per splice.



Pleated hand-drawn 1.375" diameter track with FNW8109 - 96J7001 finial.

# how-to-order

1... Select **finial/endcap** from page 8 (sold separately).

2... Select **metal track and finish**: available in 2 finishes.

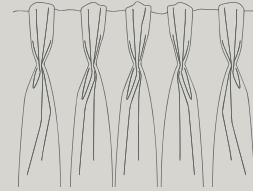

**select finish**



**95J7001**  
Platinum Gold



**33J7001**  
Brushed Silver

components included with track



track item code	finish code	track length	master carriers	glides	end stops	plugs
TRP8117	select finish	48"	one-way / center	18	2	2
TRP8118	select finish	96"	one-way / center	32	2	2

3... Select **brackets and finish**: available in 2 finishes (sold separately).  
We recommend one bracket for every 3-4 feet.

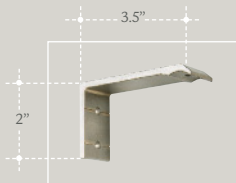

Wall bracket  
**TRB142** - select finish

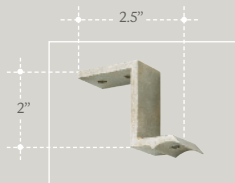

Ceiling bracket  
**TCB153** - select finish

**Additional components** (sold separately).



Plug  
**TPL150** - 10J7001

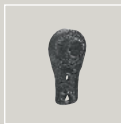

Glide  
**TGL147** - 10J7001  
Sold in packages of 10



End stop  
**TES145** - 10J7001  
Sold in pairs

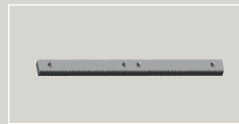

Splice  
**TSP149** - 10J7001  
**Note:** two brackets required per splice.



Pleated hand-drawn 1.5" diameter track with ECR28 - 95J7001 endcap.

E L E G A N T **G L I D E**





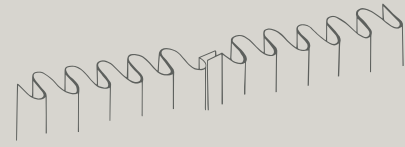

# how-to-order

1... Select finial/endcap from pages 4-7 (sold separately).

2... Select metal track and finish: available in 4 finishes.



**select finish**

			
<b>17J7001</b> Brass	<b>96J7001</b> Titanium	<b>97J7001</b> Brushed Bronze	<b>98J7001</b> Graphite

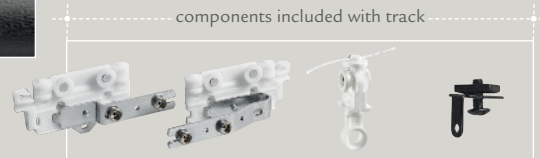

track item code	finish code	track length	fullness	master carriers*	cord snaps	end stops
<b>TRR8125</b>	select finish	72"	100% = 2x	one-way / center	36	2
<b>TRR8126</b>	select finish	96"	100% = 2x	one-way / center	48	2
<b>TRR8127</b>	select finish	72"	80% = 1.6x	one-way / center	32	2
<b>TRR8128</b>	select finish	96"	80% = 1.6x	one-way / center	44	2

\*master carriers have 3 snaps each

3... Select adjustable brackets and finish: available in 4 finishes (sold separately). We recommend one bracket for every 3-4 feet.

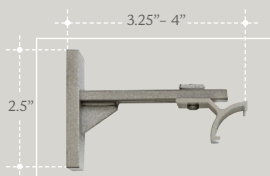

Adjustable single bracket  
**TRB8113** - select finish

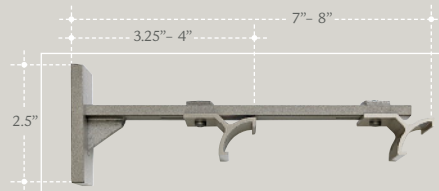

Adjustable double bracket  
**TRB8114** - select finish  
**Note:** can also be used as single extension bracket.



Adjustable ceiling bracket  
**TCB8115** - select finish

### Additional components (sold separately).



End stop  
**TES8120** - 10J7001



Butt-master  
**CBM8219** - 90J7001 White  
Sold in pairs



Splice  
**TSP8116** - 10J7001  
**Note:** one bracket required per splice.



Cord snaps (24 feet)  
80%: **RFC8233** - 90J7001 White  
100%: **RFC8234** - 90J7001 White  
**Note:** when splicing a Ripplefold® track for a one-way draw you are required to order extra cord snaps in one continuous strand. Choose item code above to suit your fullness (80% or 100% fullness).



Ripplefold® hand-drawn 1.375" diameter track with **FNW8108** - 17J7001 finial.

# how-to-order

1... **Select finial/endcap** from page 8 (sold separately).

2... **Select metal track and finish:** available in 2 finishes.

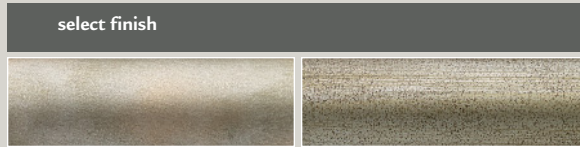

95J7001  
Platinum Gold

33J7001  
Brushed Silver

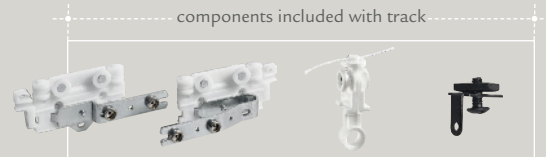
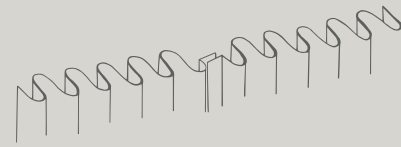

track item code	finish code	track length	fullness	master carriers*	cord snaps	end stops
TRR8121	select finish	48"	100% = 2x	one-way / center	24	2
TRR8123	select finish	96"	100% = 2x	one-way / center	48	2
TRR8122	select finish	48"	80% = 1.6x	one-way / center	22	2
TRR8124	select finish	96"	80% = 1.6x	one-way / center	44	2

\*master carriers have 3 snaps each

3... **Select brackets and finish:** available in 2 finishes (sold separately).

We recommend one bracket for every 3-4 feet.



Wall bracket  
TRB142 - select finish

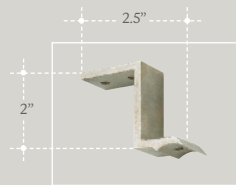

Ceiling bracket  
TCB153 - select finish

## Additional components (sold separately).



Cord snaps (24 feet)  
80%: RFC8233 - 90J7001 White  
100%: RFC8234 - 90J7001 White  
**Note:** when splicing a Ripplefold® track for a one-way draw you are required to order extra cord snaps in one continuous strand. Choose item code above to suit your fullness (80% or 100% fullness).



Splice  
TSP149 - 10J7001  
**Note:** two brackets required per splice.



Plug  
TPL150 - 10J7001



End stop  
TES8120 - 10J7001



Butt-master  
CBM8219 - 90J7001 White  
Sold in pairs



Ripplefold® hand-drawn 1.5" diameter track with ECR28 - 33J7001 endcap.

E L E G A N T G L I D E

## GLOSSARY OF TERMS

**Butt-Master:**

A center carrier used to create a continuous flow with Ripplefold® treatment without overlap.

**Center Draw:**

Two panels designed to draw in to meet at the center point of the opening.

**Cord Snaps:**

Plastic runners with snaps on a cord that run inside a drapery track. Used with Ripplefold® drapery treatments.

**Ease:**

The extra inches added to the finished width measurement to offset the bounce back (tension) when the panels are drawn closed.

**End Stops:**

A fixed glide that locks into place to prevent drapery panels from passing the desired closure.

**Fling Rod:**

A wand that guides the drapery open or closed without handling the drape by hand. They connect to the leading edge at the top of the drapery and keep the drapes clean.

**Fullness:**

The extra fabric that is needed to create the volume of the drapery panels.

**Glides:**

Plastic runners that run independently inside a drapery track. Used for mounting pleated drapery on to the track.

**Hand Drawn:**

Tracks that are opened and closed by hand without the use of a cord or motor. Fling rod may be used.

**Hook Hang:**

The distance from the top of the drape to top of the hook. The type of the rod used will determine the placement of the hooks.

**Master Carrier:**

Supports the moving leading edge of the drape. This could be in the center of the rod for a center draw or at the end for a one-way draw.

**One-Way Draw:**

A panel designed to draw in one way only.

**Overlap:**

The part of the drapery panel which rides the master carrier of a track and overlaps in the center when draperies are drawn closed.

**Pleat:**

The decorative distribution of the fullness across the top of the drape. Standard pleated headers recommend 2.5x fullness.

**Projection:**

The distance between the wall and the front of the rod.

**Return:**

The distance from the rod to the wall or casing where the bracket is attached. The return is the amount of drapery that covers this space.

**Ripplefold®:**

A track system that creates smooth and continuous “S” like folds.

**Show Length:**

The length of a decorative rod that is seen once the rod and drapes are installed. This is typically shorter than the length required, as finials and brackets need to be accommodated.

**Splice:**

To create longer rods, splices can be used to attach two rods together. A bracket should be installed at the placement of the splice to ensure the splice is stable.

**Splice and Joiner Plate:**

When a splice is used with wood fascia to join two rods together, a joiner plate acts as a decorative attachment to cover the seam created.

**Stack-Back:**

The amount of space the drapery occupies when in a fully opened position.





2" hand-drawn & motorized **WOOD** gallery

---

8 finishes

---

10 finial styles

---

E L E G A N T **G L I D E**

with **RIPPLEFOLD**® systems – drapery hardware collection



SCAN IMAGE WITH JF APP

**Click and Scan** over the image with our JF app to discover how easy our systems are to use.

BRUSHED SILVER - 33J7001



PLATINUM GOLD - 95J7001



Hand-painted resin finials available in 2 finishes, refer to page 21. For rod/track options, refer to pages 22 - 31.

72"

96"

2" diameter wood

# STAINED WOOD GALLERY

2"



STONE - 92J7001

ASH - 94J7001

Finials available in 6 finishes, refer to page 21.  
For rod/track options, refer to pages 22 - 31.

E L E G A N T **G L I D E**



CHESTNUT - 34J7001



PICKLED OAK - 12J7001



72"

96"

2" diameter wood

# STAINED WOOD GALLERY

2"



**FNW176** - 38J7001 / L: 5.25" - H: 3.75"



**FNT198** - 38J7001 / L: 5" - H: 3.25"

**Motorization** available. Refer to pages 28 - 31 for Pleated and Ripplefold® options.



**FNW174** - 38J7001 / L: 7" - H: 4.5"



**FNT8135** - 99J7001 / L: 5" - H: 3.25"



**FNW176** - 99J7001 / L: 5.25" - H: 3.75"



**FNT8136** - 99J7001 / L: 5.25" - H: 3.75"

CHOCOLATE - 38J7001

EBONY - 99J001

E L E G A N T **G L I D E**

## FREQUENTLY ASKED QUESTIONS

**Q: What type of systems are offered in this catalogue?**

**A:** Our Elegant Glide catalogue offers both hand-drawn and motorized systems, Ripplefold®, Pleated and C-ring options where applicable.

**Q: What type of drapery headers can be used on the pleated track system?**

**A:** French Pleat, Top Pinch, Inverted, Pinch pleat and more.

**Q: What hook hang is suggested for the metal, wood gallery & motorized systems?**

**A:** 1/2" hook hang, however, we recommend that you refer to your workroom and installer for placement.

**Q: What is the difference between 80% & 100% fullness for Ripplefold®?**

**A:** 80% = 1.6x fullness and 100% = 2x fullness.

**Q: Is the Ripplefold® tape provided with the track?**

**A:** No, refer to your drapery workroom for Ripplefold® snap tape.

**Q: Can the fascia be installed as a ceiling mount?**

**A:** No, although a track only system may be ordered without fascia.

**Q: Can I order snap cord and master carriers in brown?**

**A:** No, snap cord and master carrier are only available in white only. Note, these are not seen after installation.

**Q: Can I purchase a fling rod to match my track finish exactly?**

**A:** Our fling rods are offered in 3 colors. Although, these may not be a direct match to all finishes they will coordinate with them.

**Q: Are the tiebacks sold with posts or do the posts need to be ordered separately?**

**A:** Yes, all tiebacks are complete with posts. For this catalogue only.

**Q: Is custom sizing available for all rods?**

**A:** No, custom sizes are only offered with our motorized track.

**Q: What are the dimensions of the battery and motor?**

**A:** Our motorized system's motor measures 3" wide x 10" high and the battery measure 3" wide x 4" high.

**Q: What is the battery life for the motorized system?**

**A:** 2 years, depending on use.

**Q: What is the warranty on our motorized track system?**

**A:** 3 year limited warranty.

**Q: What is the total weight the motorized track can carry?**

**A:** Motorized track maximum weight is 100 lbs. per 13 ft. If longer than 13 feet, you must deduct 2.5lbs. for every additional foot.

**Q: Can two motors be used on one track?**

**A:** No, the motorized track system can only accommodate one motor per track.

**Q: How many remotes do I need if I order more than one track for a single room?**

**A:** Our remote can be programmed to control up to 15 drapery treatments.

**Q: What is the delivery time for motorized track system?**

**A:** Delivery is approximately 2-3 weeks for motorized (this may vary based on ship-to location). All systems are custom.

**Q: What type of battery is used for the remote control?**

**A:** 3V Lithium Coin Cell Battery, model # CR2450.



● Due to differences in industry standards we recommend track components be shipped directly to your workroom prior to sewing to prevent any manufacturing issues. Most importantly master carriers should be in the hands of the workroom for proper placement.

● Track systems allow the use of multiple brackets and maintain operability, the number of brackets recommended is a general guideline. If your drapes are heavier than normal or extremely tall we recommend adding more for further support.

**For inquiries** please contact your Sales Representative or JF Fabrics Customer Service at

**CAN:** 800.268.2050, **US:** 800.461.1349



# wood finishes sample chips are available on page 35

Pleated & Ripplefold® fascia		decorative rods		select finish	
------------------------------	--	-----------------	--	---------------	--

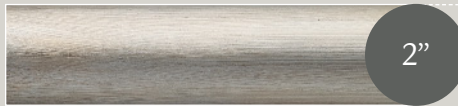
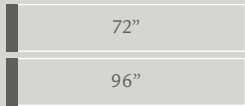
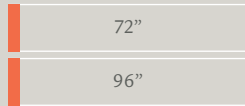

95J7001 - Platinum Gold

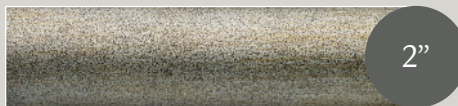
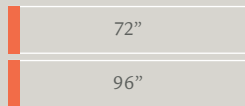

33J7001 - Brushed Silver

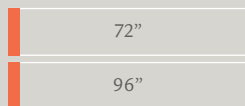

95J7001 - Platinum Gold

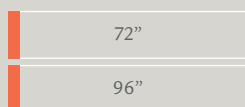

33J7001 - Brushed Silver

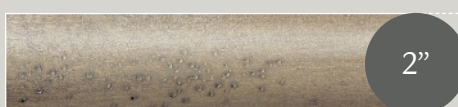
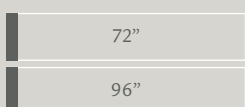
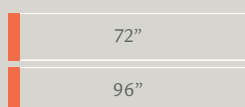

94J7001 - Ash

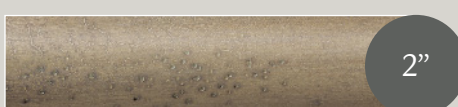
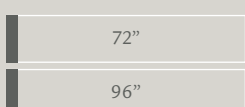
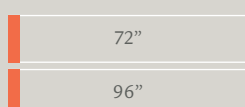

92J7001 - Stone

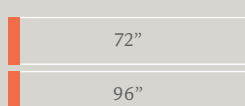

12J7001 - Pickled Oak

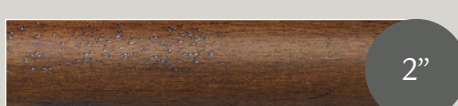
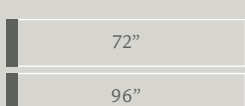
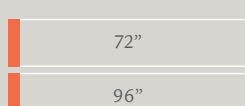

34J7001 - Chestnut

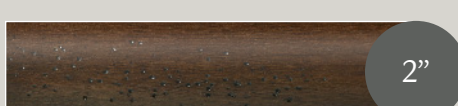

38J7001 - Chocolate

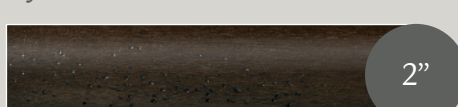
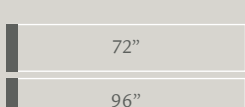

99J7001 - Ebony

Painted wood finishes

Stained wood finishes



# how-to-order

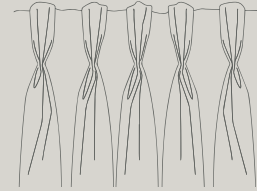

1... Select **finial / endcap** from pages 16 - 19 (sold separately).

2... Select **wood fascia**: available in 2 painted wood and 6 stained wood finishes. Fascia includes components below.



95J7001  
Platinum Gold

33J7001  
Brushed Silver

95J7001  
Platinum Gold

33J7001  
Brushed Silver

components included with track in color as shown



fascia item code	finish code	length	track	master carriers	glides	end stops	bracket plates
FAP8131 - plain	select <b>painted</b> finish	72"	1	one-way / center	24	2	3
FAP8137 - reeded	select <b>painted</b> finish	72"	1	one-way / center	24	2	3
FAP8132 - plain	select <b>painted</b> finish	96"	1	one-way / center	32	2	3
FAP8138 - reeded	select <b>painted</b> finish	96"	1	one-way / center	32	2	3

stained wood finish							
94J7001 Ash	92J7001 Stone	12J7001 Pickled Oak	34J7001 Chestnut	38J7001 Chocolate	99J7001 Ebony		
FAP8129 - plain	select <b>stained</b> finish	72"	1	one-way / center	24	2	3
FAP8130 - plain	select <b>stained</b> finish	96"	1	one-way / center	32	2	3

3... Select **bracket and finish** (sold separately). We recommend a bracket every 3-4 feet.

**Note:** track sold with fascia. **Bracket** measurements do not include fascia. Add 1.5" for fascia.

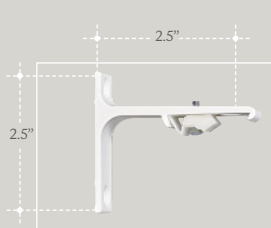

Single bracket  
TRB8143 - 39J7001 Brown  
TRB8143 - 90J7001 White

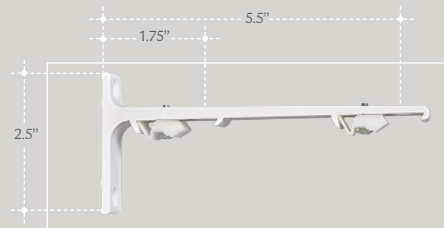

Double bracket  
TRB8144 - 39J7001 Brown  
TRB8144 - 90J7001 White  
**Note:** can also be used as single extension bracket.

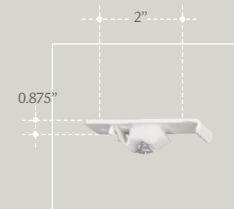

Ceiling bracket (track only)  
TCB8145 - 90J7001 White  
**Note:** cannot be used with fascia.

**Additional components (sold separately).**



Bracket plate  
**BCW8146** – select finish to match fascia.  
**Note:** 3 bracket plates are included with fascia.



Solid 0.75" extension block  
**BEW8147** – select finish to match fascia.



Glide  
**TGL8119** – 90J7001 White  
**TGL8119** – 39J7001 Brown



End stop  
**TES8157** – 90J7001 White  
**TES8157** – 39J7001 Brown



Items sold separately.

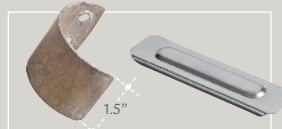

Splice and joiner plate  
**SPL8177** – select finish to match fascia.  
**Note:** two brackets required per splice.



Track splice  
**SPL8227** – 10J7001



Fling rod  
**FLW8110**  
17J7001



Fling rod  
**FLW8110**  
96J7001







Fling rod  
**FLW8110**  
99J7001

**Track only system**

Brackets (sold separately).

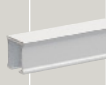

components included with track

	track item code	finish code	length	master carriers	glides	glides	end stops	end stops
	<b>TRP8141</b>	90J7001 – white	72"	one-way / center	24	n/a	2	n/a
	<b>TRP8142</b>	90J7001 – white	96"	one-way / center	32	n/a	2	n/a
	<b>TRP8139</b>	39J7001 – brown	72"	one-way / center	n/a	24	n/a	2
	<b>TRP8140</b>	39J7001 – brown	96"	one-way / center	n/a	32	n/a	2

# how-to-order

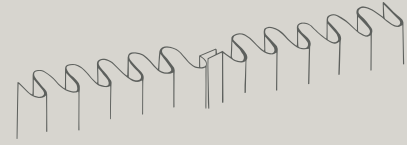

1... Select finial / endcap from pages 16 - 19 (sold separately).

2... Select wood fascia: available in 2 painted wood and 6 stained wood finishes. Fascia includes components below.

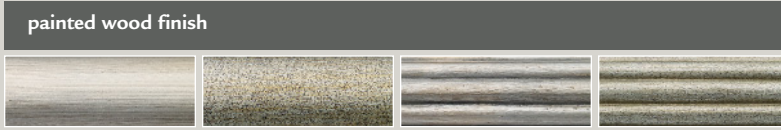

95J7001  
Platinum Gold

33J7001  
Brushed Silver

95J7001  
Platinum Gold

33J7001  
Brushed Silver

components included with track in color as shown



fascia item code	finish code	length	fullness	track	master carriers*	cord snaps	end stops	bracket plates
FAR8160 - plain	select painted finish	72"	100% = 2x	1	one-way / center	36	2	3
FAR8161 - plain	select painted finish	96"	100% = 2x	1	one-way / center	48	2	3
FAR8183 - reeded	select painted finish	72"	100% = 2x	1	one-way / center	36	2	3
FAR8184 - reeded	select painted finish	96"	100% = 2x	1	one-way / center	48	2	3
FAR8181 - plain	select painted finish	72"	80% = 1.6x	1	one-way / center	32	2	3
FAR8182 - plain	select painted finish	96"	80% = 1.6x	1	one-way / center	44	2	3
FAR8162 - reeded	select painted finish	72"	80% = 1.6x	1	one-way / center	32	2	3
FAR8163 - reeded	select painted finish	96"	80% = 1.6x	1	one-way / center	44	2	3

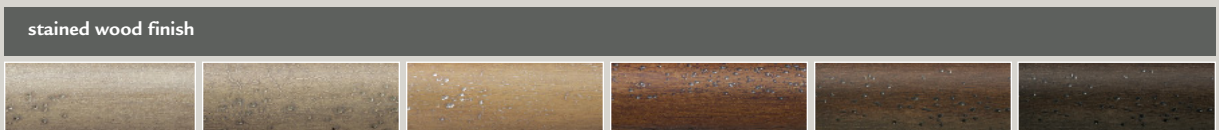

94J7001  
Ash

92J7001  
Stone

12J7001  
Pickled Oak

34J7001  
Chestnut

38J7001  
Chocolate

99J7001  
Ebony

FAR8158 - plain	select stained finish	72"	100% = 2x	1	one-way / center	36	2	3
FAR8159 - plain	select stained finish	96"	100% = 2x	1	one-way / center	48	2	3
FAR8179 - plain	select stained finish	72"	80% = 1.6x	1	one-way / center	32	2	3
FAR8180 - plain	select stained finish	96"	80% = 1.6x	1	one-way / center	44	2	3

\*master carriers have 3 snaps each

3... Select bracket and finish (sold separately). We recommend a bracket every 3-4 feet.

Note: track sold with fascia. Bracket measurements do not include fascia. Add 1.5" for fascia.

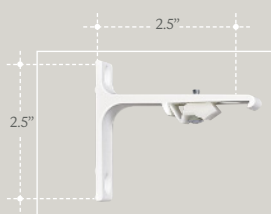

Single bracket  
TRB8143 - 39J7001 Brown  
TRB8143 - 90J7001 White

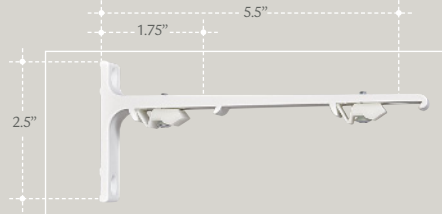

Double bracket  
TRB8144 - 39J7001 Brown  
TRB8144 - 90J7001 White  
Note: can also be used as single extension bracket.

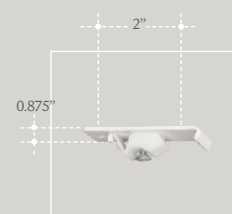

Ceiling bracket (track only)  
TCB8145 - 90J7001 White  
Note: cannot be used with fascia.

**Additional components (sold separately).**



Bracket plate  
**BCW8146** – select finish to match fascia.  
**Note:** 3 bracket plates are included with fascia.



Solid 0.75" extension block  
**BEW8147** – select finish to match fascia.



Butt-master  
**CBM8219** – 90J7001 White  
Sold in pairs



End stop  
**TES8226** – 90J7001 White  
**TES8226** – 39J7001 Brown

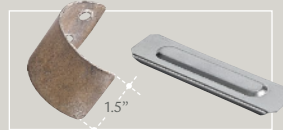

Splice and joiner plate  
**SPL8177** – select finish to match fascia.  
**Note:** two brackets required per splice.



Track splice  
**SPL8227** – 10J7001



Cord snaps (24 feet)  
80%: **RFC8233** – 90J7001 White  
100%: **RFC8234** – 90J7001 White

**Note:** when splicing a Ripplefold® track for a one-way draw you are required to order extra cord snaps in one continuous strand. Choose item code above to suit your fullness (80% or 100% fullness).



**Track only system**

Brackets (sold separately).

track item code	finish code	length	fullness	master carriers*	cord snaps	end stops	end stops
<b>TRR8168</b>	90J7001 – white	72"	100% = 2x	one-way / center	36	2	n/a
<b>TRR8169</b>	90J7001 – white	96"	100% = 2x	one-way / center	48	2	n/a
<b>TRR8170</b>	90J7001 – white	72"	80% = 1.6x	one-way / center	32	2	n/a
<b>TRR8171</b>	90J7001 – white	96"	80% = 1.6x	one-way / center	44	2	n/a
<b>TRR8164</b>	39J7001 – brown	72"	100% = 2x	one-way / center	36	n/a	2
<b>TRR8165</b>	39J7001 – brown	96"	100% = 2x	one-way / center	48	n/a	2
<b>TRR8166</b>	39J7001 – brown	72"	80% = 1.6x	one-way / center	32	n/a	2
<b>TRR8167</b>	39J7001 – brown	96"	80% = 1.6x	one-way / center	44	n/a	2

\*master carriers have 3 snaps each

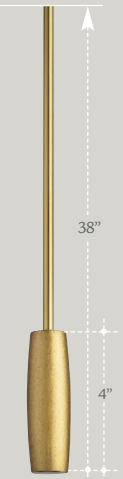

Fling rod  
**FLW8110**  
17J7001



Fling rod  
**FLW8110**  
96J7001







Fling rod  
**FLW8110**  
99J7001



# how-to-order

1... Select finial/endcap from page 16 (sold separately).

2... Select rod and finish: available as plain and reeded solid wood in 2 painted finishes.

wood rod item code	rod length	select painted wood finish			
RDW91 - reeded	72"	 95J7001 Platinum Gold	 33J7001 Brushed Silver	 95J7001 Platinum Gold	 33J7001 Brushed Silver
RDW92 - reeded	96"				
RDW93 - plain	72"				
RDW94 - plain	96"				

3... Select bracket, rings and finish. We recommend a bracket every 3-4 feet.



Ring  
**RIR8229** - select finish  
0.5" W / 3.25" OD  
2.25" ID / 0.5" drop  
Sold in packages of 7



3.75"  
4.625"  
Small wall bracket  
**BRW8230** - select finish



5.75"  
6.125"  
Large wall bracket  
**BRW8231** - select finish



3.5"  
3.125"  
Loop bracket  
**BRW8232** - select finish



Passing C-ring  
**RIR8150** - select finish  
0.625" W / 3.75" OD  
2" ID / 0.5" drop  
Sold in packages of 7



3.75"  
4.625"  
Small wall bracket for passing C-ring  
**BRW8151** - select finish



5.75"  
4.5"  
Large wall bracket for passing C-ring  
**BRW8152** - select finish

Additional accessories (sold separately).



Splice  
**SPW101** - 10J7001



Note: all items on this page are for painted only.

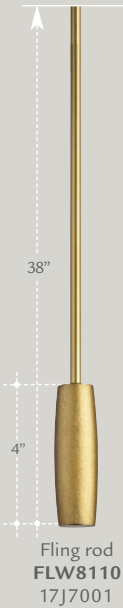

# how-to-order

1... **Select finial** from pages 17 - 19 (sold separately).

2... **Select rod and finish:** available in 6 stained wood finishes.

wood rod item code	rod length
RDW181	72"
RDW182	96"

**select stained wood finish**



**94J7001**  
Ash

**92J7001**  
Stone

**12J7001**  
Pickled Oak

**34J7001**  
Chestnut

**38J7001**  
Chocolate

**99J7001**  
Ebony

3... **Select bracket, rings and finish.** We recommend a bracket every 3-4 feet.



Ring  
**RIR184** - select finish  
0.5" W / 3.25" OD  
2.25" ID / 0.5" drop  
Sold in packages of 7



Small wall bracket  
**BRW178** - select finish



Large wall bracket  
**BRW179** - select finish



Loop bracket  
**BRW180** - select finish



Passing C-ring  
**RIR8150** - select finish  
0.625" W / 3.75" OD  
2" ID / 0.5" drop  
Sold in packages of 7



Small wall bracket for passing C-ring  
**BRW8151** - select finish

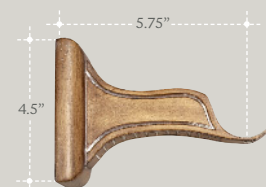

Large wall bracket for passing C-ring  
**BRW8152** - select finish



**Additional accessories**  
(sold separately).



Tieback  
**TBW183** - select finish



Splice  
**SPW216** - 10J7001

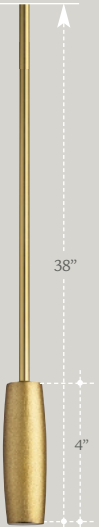

Fling rod  
**FLW8110**  
17J7001



Fling rod  
**FLW8110**  
96J7001



Fling rod  
**FLW8110**  
99J7001

# how-to-order

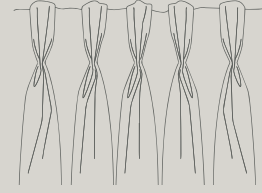

1... Select finial / endcap from pages 16 - 19 (sold separately).

2... Select wood fascia/ track and finish: available in 2 painted wood and 6 stained wood finishes. Fascia includes components below.

select painted wood finish		select stained wood finish					
95J7001 Platinum Gold	33J7001 Brushed Silver	94J7001 Ash	92J7001 Stone	12J7001 Pickled Oak	34J7001 Chestnut	38J7001 Chocolate	99J7001 Ebony

components included in color shown



fascia item code	finish code	length	track	master carriers (select draw)	glides/foot	track return clip	bracket plates
MPP8195	select finish	custom**	1	left, right or center	4	2	3

**Note:** Motorized track maximum weight is 100 lbs. per 13 ft. If longer than 13 feet, you must deduct 2.5 lbs. for every additional foot. A motorized track can be ordered up to 30 feet in length. **\*\*Custom length:** Fascia and track sold per foot - 3 feet minimum.

3... Select motor: choose motor option and remote.



	item code	finish code	motor	battery	charger/cord	plug-in motor	remote control
battery operated	BPK8224	90J7001 - white	1	1	1	n/a	n/a
plug-in option	PPK8225	90J7001 - white	n/a	n/a	1	1	n/a
remote control	RMT8188	90J7001 - white	n/a	n/a	n/a	n/a	1

4... Select bracket (sold separately). We recommend a bracket every 3-4 feet.

**Note:** track and components included with fascia are white. **Bracket** measurements do not include fascia. Add 1.5" for fascia.

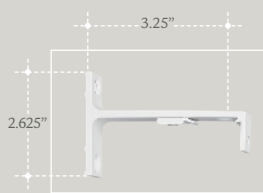

Single bracket for motorized TRB8190 - 90J7001 White

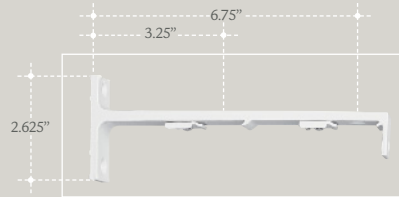

Double bracket for motorized TRB8189 - 90J7001 White **Note:** can also be used as single extension bracket.

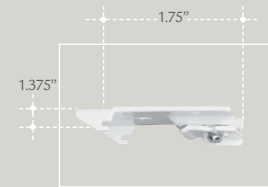

Ceiling bracket for motorized TRC8191 - 90J7001 White **Note:** cannot be used with fascia.

# how-to-order

1... **Select track only system**  
Brackets (sold separately).

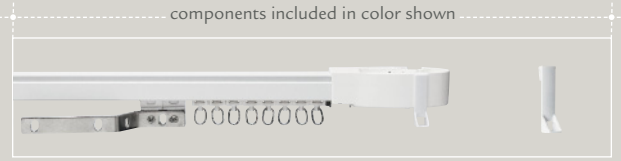

track item code	finish code	length	track	master carriers (select draw)	glides/foot	track return clip
MPP8207	90J7001 - white	custom**	1	left, right or center	4	2

**Note:** Motorized track maximum weight is 100 lbs. per 13 ft. If longer than 13 feet, you must deduct 2.5 lbs. for every additional foot. A motorized track can be ordered up to 30 feet in length. **\*\*Custom length:** Track sold per foot - 3 feet minimum.

2... **Select motor:** choose motor option and remote.



	item code	finish code	motor	battery	charger/cord	plug-in motor	remote control
<b>battery operated</b>	BPK8224	90J7001 - white	1	1	1	n/a	n/a
<b>plug-in option</b>	PPK8225	90J7001 - white	n/a	n/a	1	1	n/a
<b>remote control</b>	RMT8188	90J7001 - white	n/a	n/a	n/a	n/a	1

3... **Select bracket** (sold separately). We recommend a bracket every 3-4 feet.

**Note:** track and components included are white. **Bracket** measurements do not include fascia. Add 1.5" for fascia.

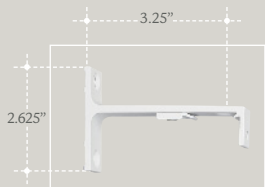

Single bracket for motorized **TRB8190** - 90J7001 White

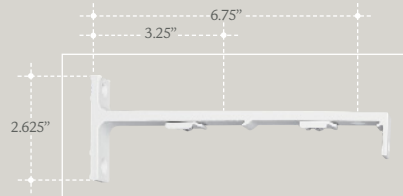

Double bracket for motorized **TRB8189** - 90J7001 White  
**Note:** can also be used as single extension bracket.

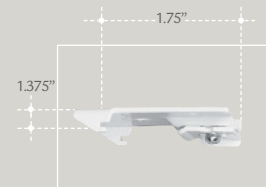

Ceiling bracket for motorized **TRC8191** - 90J7001 White  
**Note:** cannot be used with fascia.

## Additional components (sold separately).



Remote control **RMT8188** - 90J7001 White



Battery **MBT8192** - 90J7001 White



Charger/cord for MMT8221 **MCR8193** - 90J7001 White



Extra motor **MMT8221** - 90J7001 White



Extra plug-in motor (charger included) **MMT8222** - 90J7001 White



Track splice/joiner plate **SPM8220** - select finish to match fascia. Includes track splice and joiner plate.  
**Note:** two brackets required per splice.



Splice for track only **SPM8223** - 90J7001 White



Bracket plate for motorized **BCW8194** - select finish to match fascia.  
**Note:** 3 bracket plates are included with fascia.



# how-to-order

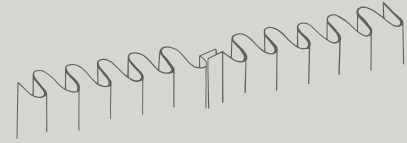

1... Select finial / endcap from pages 16 - 19 (sold separately).

2... Select wood fascia/ track and finish: available in 2 painted wood and 6 stained wood finishes. Fascia includes components below.

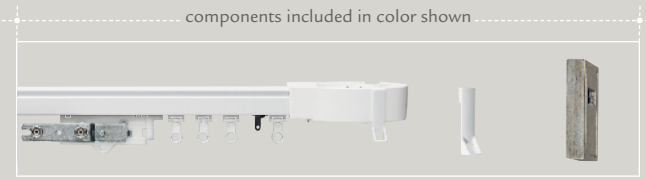
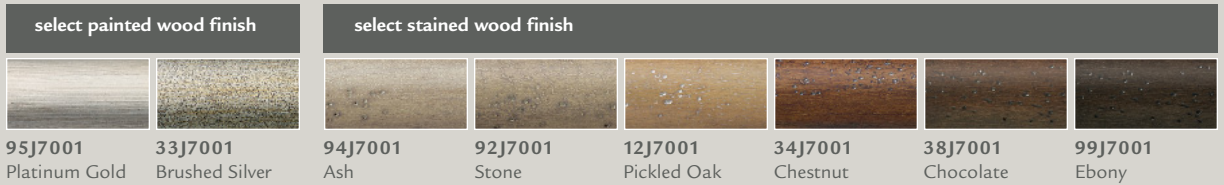

fascia item code	finish code	length	fullness	track	master carriers* (select draw)	cord snaps/ foot	track return clip	bracket plates
MRF8199	select finish	custom**	80% = 1.6x	1	left, right or center	7	2	3
MRF8200	select finish	custom**	100% = 2x	1	left, right or center	8	2	3

Note: Motorized track maximum weight is 100 lbs. per 13 ft. If longer than 13 feet, you must deduct 2.5 lbs. for every additional foot. A motorized track can be ordered up to 30 feet in length. \*Master carriers have 3 snaps each. \*\*Custom length: Fascia and track sold per foot - 3 feet minimum.

3... Select motor: choose motor option and remote



	item code	finish code	motor	battery	charger/ cord	plug-in motor	remote control
battery operated	BPK8224	90J7001 - white	1	1	1	n/a	n/a
plug-in option	PPK8225	90J7001 - white	n/a	n/a	1	1	n/a
remote control	RMT8188	90J7001 - white	n/a	n/a	n/a	n/a	1

4... Select bracket (sold separately). We recommend a bracket every 3-4 feet.

Note: track and components included with fascia are white. Bracket measurements do not include fascia. Add 1.5" for fascia.

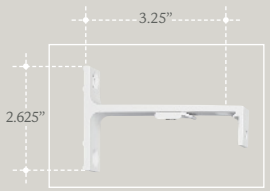

Single bracket for motorized TRB8190 - 90J7001 White

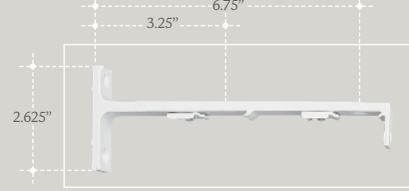

Double bracket for motorized TRB8189 - 90J7001 White  
Note: can also be used as single extension bracket.

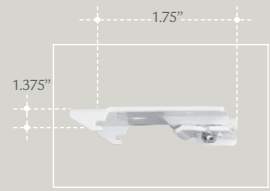

Ceiling bracket for motorized TRC8191 - 90J7001 White  
Note: cannot be used with fascia.

# how-to-order

1... **Select track only system**  
Brackets (sold separately).

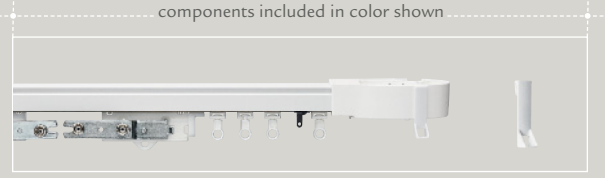

track item code	finish code	length	fullness	track	master carriers* (select draw)	cord snaps/ foot	track return clip
MRF8211	90J7001 - white	custom**	80% = 1.6x	1	left, right or center	7	2
MRF8212	90J7001 - white	custom**	100% = 2x	1	left, right or center	8	2

**Note:** Motorized track maximum weight is 100 lbs. per 13 ft. If longer than 13 feet, you must deduct 2.5 lbs. for every additional foot. A motorized track can be ordered up to 30 feet in length. \*Master carriers have 3 snaps each.  
\*\*Custom length: Track sold per foot - 3 feet minimum.

2... **Select motor:** choose motor option and remote.



	item code	finish code	motor	battery	charger/ cord	plug-in motor	remote control
<b>battery operated</b>	BPK8224	90J7001 - white	1	1	1	n/a	n/a
<b>plug-in option</b>	PPK8225	90J7001 - white	n/a	n/a	1	1	n/a
<b>remote control</b>	RMT8188	90J7001 - white	n/a	n/a	n/a	n/a	1

3... **Select bracket** (sold separately). We recommend a bracket every 3-4 feet.

**Note:** track and components included are white. **Bracket** measurements do not include fascia. Add 1.5" for fascia.

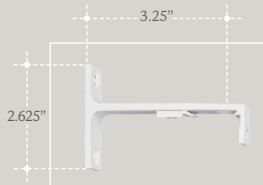

Single bracket for motorized  
**TRB8190** - 90J7001 White

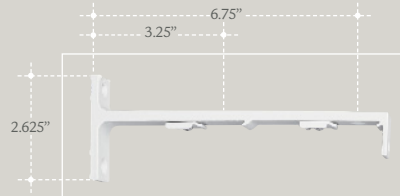

Double bracket for motorized  
**TRB8189** - 90J7001 White  
**Note:** can also be used as single extension bracket.

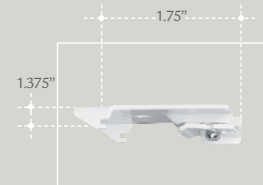

Ceiling bracket for motorized  
**TRC8191** - 90J7001 White  
**Note:** cannot be used with fascia.

## Additional components (sold separately).



Remote control  
**RMT8188** - 90J7001 White



Battery  
**MBT8192** - 90J7001 White



Charger/cord for MMT8221  
**MCR8193** - 90J7001 White



Extra motor  
**MMT8221** - 90J7001 White



Extra plug-in motor  
(charger included)  
**MMT8222** - 90J7001 White



Track splice/joiner plate  
**SPM8220** - select finish to match fascia.  
Includes track splice and joiner plate.  
**Note:** two brackets required per splice.



Splice for track only  
**SPM8223** - 90J7001 White



Bracket plate for motorized  
**BCW8194** - select finish to match fascia.  
**Note:** 3 bracket plates are included with fascia.

Date	Account#	Account name
Contact	Shipping to address	
Contact 2	City	State/Province
Purchase order#	Zip Code / Postal Code	
Phone		
Phone		
Email	Sidemark	

**Track Systems Pleated and Ripplefold®** – Consult catalogue and price list for detailed specifications – Brackets sold separately

QTY	ITEM CODE	FINISH CODE	TRACK LENGTH	DESCRIPTION	UNIT PRICE	EXTENDED PRICE
					\$	\$
					\$	\$
					\$	\$
					\$	\$
					\$	\$

**Decorative Systems** – Consult catalogue and price list for detailed specifications – Brackets sold separately

QTY	ITEM CODE	FINISH CODE	ROD LENGTH	DESCRIPTION	UNIT PRICE	EXTENDED PRICE
					\$	\$
					\$	\$
					\$	\$
					\$	\$
					\$	\$

**Accessories for Tracks & Decorative Systems** – Order Finials, Brackets (we recommend a bracket every 3-4 ft) and Accessories here

QTY	UNIT (EA/PR/PKG)	ITEM CODE	FINISH CODE	DESCRIPTION	UNIT PRICE	EXTENDED PRICE
					\$	\$
					\$	\$
					\$	\$
					\$	\$
					\$	\$

Date	Account#	Account name
Contact	Shipping to address	
Contact 2	City	State/Province
Purchase order#	Zip Code/Postal Code	
Phone		
Phone		
Email	Sidemark	

**Wood Fascia with Track for Motorized, Pleated and Ripplefold® Systems** – Consult catalogue and price list for detailed specifications – Brackets sold separately

QTY	ITEM CODE	FINISH CODE	CUSTOM LENGTH Inches ONLY	DRAW PREFERENCE (For One-way Indicate Left or Right) Center One-way L or R		DESCRIPTION	UNIT PRICE	EXTENDED PRICE
							\$	\$
							\$	\$
							\$	\$
							\$	\$
							\$	\$

**Motor – Battery operated or Plug-in option & Remote** – Motor sold in package or separately

QTY	UNIT (EA/PR/PKG)	ITEM CODE	FINISH CODE	MOTOR LOCATION		DESCRIPTION	UNIT PRICE	EXTENDED PRICE
				LEFT	RIGHT			
							\$	\$
							\$	\$
							\$	\$
							\$	\$
							\$	\$

**Accessories for Motorized** – Order Finalials, Brackets (we recommend a bracket every 3-4 ft) and Splice if required

QTY	UNIT (EA/PR/PKG)	ITEM CODE	FINISH CODE	DESCRIPTION	UNIT PRICE	EXTENDED PRICE
					\$	\$
					\$	\$
					\$	\$
					\$	\$
					\$	\$



1.375"

1.5"

2"

**ELEGANT GLIDE** drapery hardware general information + countertop display

**Elegant Glide** drapery hardware collection features both hand-drawn and motorized systems, Ripplefold® Pleated and C-ring options where applicable. This interactive catalogue will assist with measuring and installation. Simply download the JF app to unlock the video or visit [jffabrics.com](http://jffabrics.com). For further assistance, contact your JF Sales Representative.

**Important Facts:**

Please note as the motorized systems require custom assembly, 2 to 3 week lead times are required. The color of the components supplied for metal tracks systems cannot be changed. Motor options are battery operated or plug-in. Hardwired is not available.

**Installation:**

Professional installation is required.

**Contract:**

Elegant Glide drapery hardware collection is versatile and commonly used in commercial installations. Contact your JF Sales Representative for contract quotations.

**Ordering:** Always include item and finish code.

**Shipping:**

Canadian orders ship FOB Oakville, Ontario.  
US orders ship FOB Tonawanda, NY.

**Claims or Returns Policy:**

- No claims or returns will be considered after 30 days from invoice date.
- Our liability for any claim is always limited to the value of the invoice, regardless of the nature of the claim.
- Customer error – full credit less 25% restocking charge and freight costs.
- Minimum restocking charge of \$50.00.
- No returns on rods that have been cut.
- All Sales for Clearout products are final, and no returns will be accepted.

**Cancellation & Returns:**

All motorization orders are considered custom as they are produced individually for each order. Cancellations, changes and returns are not permitted once an order is processed.

**A return authorization number** must be obtained for all returns. JF Fabrics will arrange for pickup of the shipment. A 25% or minimum \$50.00 restocking charge and freight charges apply. Items being picked up must be packaged in the same fashion as they were received, to ensure they are in perfect quality for credit.

**COUNTERTOP DISPLAY**

Complement your drapery hardware catalogue with our countertop display (sold separately). Reference #J7002. Purchase price: \$100 each.



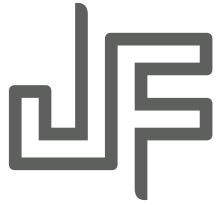

Sample chips for color only

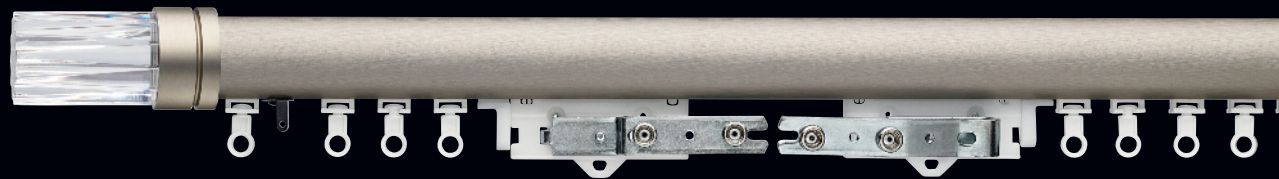

SCAN LOGO WITH JF APP

jffabrics.com



 always in stock

 same day shipping

